

REV 1.4

# First Solar Series 7 TR1 Module - USER GUIDE

## MPD-00752-07-US

Not Intended for Residential Use in USA or rooftop applications, including commercial and industrial.

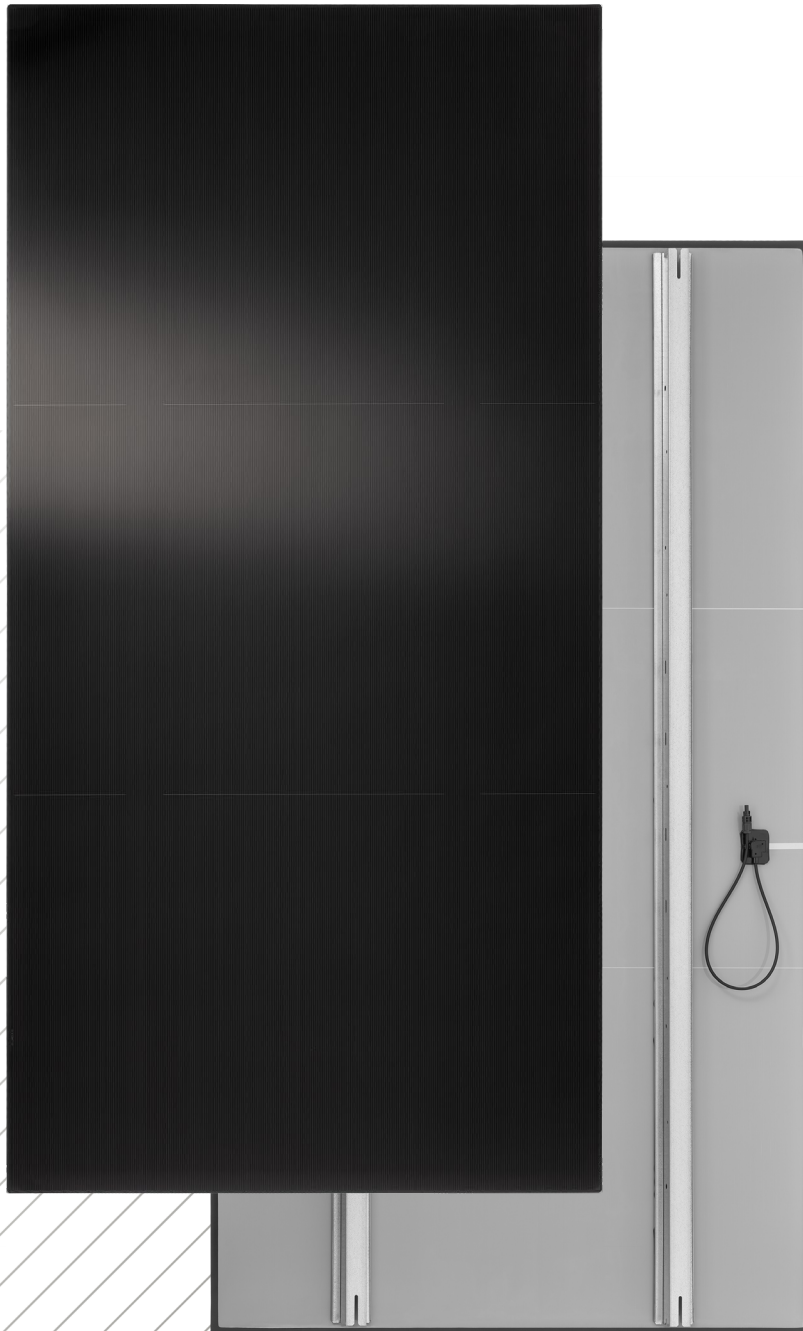

## NOTICE

First Solar reserves the right to make changes in solar module design and/or specifications at any time without notice. Accordingly, the reader is cautioned to verify that data sheets are current before placing orders or finalizing system permitting and/or design. Information furnished by First Solar is believed to be accurate and reliable. However, no responsibility is assumed by First Solar or its subsidiaries for its use; nor for any infringements of patents or other rights of third parties, which may result from its use. No license is granted by implication or otherwise under any patent or patent rights of First Solar or its subsidiaries.

## CONTACT INFORMATION

For information regarding First Solar and its products, please visit [www.firstsolar.com](http://www.firstsolar.com). First Solar has an extensive library of supporting Application Notes that can be made available upon request from technical support [technicalsupport@firstsolar.com](mailto:technicalsupport@firstsolar.com).

## GLOBAL

First Solar, Inc.

P.O. Box 730

Toledo, OH USA 43697-0730

Tel: +1 (602) 414-9300

Fax: +1 (602) 414-9400

# TABLE OF CONTENTS

<b>1</b>	<b>INTRODUCTION</b>	<b>3</b>
<b>2</b>	<b>SAFETY</b>	<b>4</b>
<b>3</b>	<b>REGULATORY COMPLIANCE</b>	<b>6</b>
<b>4</b>	<b>PRODUCT IDENTIFICATION &amp; RATINGS</b>	<b>7</b>
	4.1 PRODUCT IDENTIFICATION & RATINGS	7
	4.2 WIRING SYSTEM DERATING FACTORS	8
<b>5</b>	<b>HANDLING &amp; STORAGE</b>	<b>9</b>
	5.1 TRUCK/CONTAINER UNLOADING	9
	5.2 ON-SITE PACK HANDLING	10
	5.3 ON-SITE STORAGE	11
<b>6</b>	<b>MECHANICAL SPECIFICATIONS</b>	<b>13</b>
<b>7</b>	<b>INSTALLATION &amp; MOUNTING</b>	<b>14</b>
	7.1 MOUNTING	14
	7.2 MOUNTING LOCATIONS & LOAD RATINGS	14
	7.3 BACKRAIL MOUNTING	16
	7.4 MODULE ORIENTATION	17
	7.5 MODULE SHADING CONSIDERATIONS	17
	7.6 WIRE MANAGEMENT	18
	7.7 ELECTRICAL INTERCONNECTION	19
	7.8 INVERTER COMPATIBILITY	20
	7.9 GROUNDING METHOD	21
<b>8</b>	<b>MAINTENANCE</b>	<b>23</b>
	8.1 MAINTENANCE	23
	8.2 MODULE CLEANING GUIDANCE	24
	8.3 MODULE DISPOSAL	26
<b>9</b>	<b>REVISION HISTORY</b>	<b>27</b>

# 1 INTRODUCTION

This document provides information on First Solar Series 7 TR1 modules of model type FS-7XXXA-TR1 (“XXX” references the module power rating) for system designers, installers, and maintenance personnel.

Modules are intended to be used only by qualified professionals. Modules in the USA are intended to be used exclusively in utility-scale markets. Unintended use of the products may void the warranty and subject you to liability.

Modules are designed to have a long operating life and high energy yield when installed, operated, and serviced in accordance with the instructions in this User Guide. Read this User Guide thoroughly before beginning any work related to installation, operation, or maintenance.

Please refer to your First Solar Module Warranty Terms & Conditions for module warranty terms and product return policies. Failure to follow this User Guide may void your warranty.

---

*Keep this User Guide for future reference and provide to all subsequent owners or users of the solar modules. Updates may be found at [www.firstsolar.com](http://www.firstsolar.com).*

---

# 2 SAFETY

All instructions and safety information must be read and understood before attempting to handle, install, or electrically connect First Solar modules. Failure to follow safety, installation, and handling instructions may result in injury. Only qualified personnel must install, operate, or maintain PV modules or systems. PV modules or systems are not intended to be used in USA residential settings (Residential settings must mean and refer to any building or structure intended for human habitation).

Series 7 TR1 modules are designed for 1500 VDC systems at altitudes up to 3000 m (9842 ft) per IEC 61730 and UL 61730. Series 7 TR1 modules are designed for 1000 V systems at altitudes up to 5000 m (16404 ft) per IEC 61730 and UL 61730.

Select installation locations and module support structures to ensure modules and connectors (open or mated) are never submerged in standing water.

Series 7 TR1 modules have a maximum overcurrent protection rating of 5.0 A as defined by IEC/UL 61730-1 and IEC/UL 61730-2. PV systems must be designed to comply with and provide module overcurrent protection consistent with local codes.

## DANGER



Series 7 TR1 modules may produce up to 285 Volts DC (VDC) and up to 4.5 A when exposed to sunlight. The danger increases as modules are connected together in series and/or parallel.

**A single module or multiple interconnected modules can create a lethal shock hazard during daylight hours, including periods of low light levels.**

## DANGER



**To avoid fire and/or injury** due to ground faults and associated electrical hazards:

- ▶ Do not unplug PV module connections while under load. Do not disconnect the module connectors during daylight hours unless the module is in an open circuit condition.
- ▶ Replace modules with damaged wires immediately. Keep all array wiring out of reach of non-qualified personnel.
- ▶ Do not concentrate light on the module in an attempt to increase power output.
- ▶ Never allow the PV array system voltage to exceed 1500 VDC under any condition.
- ▶ Replace broken modules immediately.
- ▶ Repair ground faults immediately.
- ▶ Do not work on modules or systems when the modules or wiring is wet.
- ▶ All building mounted PV systems must utilize Ground Fault Detector Interrupters (GFDI) and ARC Fault Circuit Interrupters to minimize risk of electrical shocks and fires.

**WARNING**

Modules must only be installed, operated, maintained or used by qualified personnel for their intended use

The conditions necessary to trigger reverse current overload (RCOL) do not occur in typical operating modes of a properly installed PV system. The system designer must ensure that modules are not subjected to RCOL. The use of GFDI devices or other advanced fault monitoring techniques can significantly reduce the likelihood of sustained ground faults. Properly selected and installed string fuses can increase protection against RCOL.

**DANGER**

**Reverse currents** higher than the rated values for a First Solar module, may result in module failure, including module breakage due to RCOL. Extreme and continuous RCOL conditions may cause a fire or create electrical shock hazards. To avoid RCOL:

- ▶ Maintain equivalent voltage in parallel strings by installing an equal number of modules per string within the same source circuit. Failure to install modules with balanced voltage in parallel strings can result in voltage imbalance.
- ▶ Incorporate measures to protect modules against RCOL for connections of parallel strings.

Modules damaged because of system-induced RCOL are not covered under the First Solar Module Warranty. Module warranty eligibility is not affected by the presence, absence, or type of reverse current protection used in a system design.

**CAUTION**

**Wear safety glasses and cut-resistant gloves** when working with non-interconnected modules or system components.

**Wear electrically rated PPE** when working with interconnected modules or system components. Select PPE based on work consistent with local and/or national standards.

**WARNING**

To avoid risk of fire, do **NOT** interconnect Series 7 TR1 modules with other FS Series modules (e.g. – Series 6, Series 4, Series 3, or Series 2) within the same interconnected string, inverter, or Maximum Power Point Tracker.

Electrically connected modules with undetected damage, e.g. caused by external impact, carry a higher risk of electric shock and fire hazard. System installation codes and standards require measures for early detection and risk reduction such as insulation monitoring and earth fault protection. See IEC 62548, IEC 60364-7-712 and IEC 63112 for guidance. Local codes apply.

# 3 REGULATORY COMPLIANCE

It is the responsibility of the installer and/or system integrator to ensure compliance with all local structural and electrical codes, which may be applicable to the installation and use of First Solar Series 7 TR1 modules.

For systems installed in North America, First Solar Series 7 TR1 modules are Listed by a Nationally Recognized Test Laboratory (NRTL) to UL 61730, the standard for Flat-Plate Photovoltaic Modules and Panels. To maintain the modules' application as a UL Listed product:

- ▶ Use only components that have been Recognized or Listed by Underwriters Laboratories (UL) for their intended purpose.
- ▶ Ensure the PV array open-circuit voltage does not exceed 1500 VDC.
- ▶ Install modules with mounting systems that have been evaluated for UL Listed application.
- ▶ Protect modules from reverse currents in excess of the 5.0 A maximum series fuse rating.
- ▶ The module is considered to be in compliance with the applicable UL standard only when the module is mounted in the manner specified by the mounting instructions in this User Guide.
- ▶ A module with exposed conductive parts is considered to be in compliance with the applicable UL standard only when it is electrically grounded in accordance with this User Guide and the requirements of the National Electrical Code, ANSI/NFPA 70.

For system installed internationally and where IEC is applicable, Series 7 TR1 modules are tested and certified per IEC 61730-1/IEC 61730-2 and meet Class II requirements for 1500 VDC systems.

Series 7 TR1 modules are tested and certified per IEC 61215-1/IEC 61215-1-2/IEC 61215-2 for a maximum system voltage of 1500 VDC.

# 4 PRODUCT IDENTIFICATION & RATINGS

## 4.1 PRODUCT IDENTIFICATION & RATINGS

Each module is equipped with a product label on the back and laser-etched identification on the front glass. The label identifies the model number, nameplate electrical ratings, and safety information. Do not remove or modify the label on the module.

The module Rated Power is denoted in the 'XXX' position of the base Model Number format of FS-7XXXA-TR1. (Example: FS-7540A-TR1 has a Rated Power of 540W).

The ratings in Table 1 are UL Listed with a tolerance of  $\pm 10\%$  unless otherwise noted.

**Note:** Electrical specifications are subject to change. See module label for final electrical ratings.

Table 1: Ratings at Standard Test Conditions (STC<sup>1</sup>)

RATED POWER <sup>2</sup> (-0/+5%)	VOLTAGE AT P <sub>MAX</sub>	CURRENT AT P <sub>MAX</sub>	OPEN CIRCUIT VOLTAGE	SHORT CIRCUIT CURRENT	MAX SYSTEM VOLTAGE	MAX SERIES FUSE
P <sub>MAX</sub> (W)	V <sub>MAX</sub> (V)	I <sub>MAX</sub> (A)	V <sub>oc</sub> (V)	I <sub>sc</sub> (A)	V <sub>sys</sub> (V)	I <sub>cf</sub> (A)
465.0	175.1	2.66	219.4	2.95	1500	5.0
470.0	176.0	2.67	220.0	2.96		
475.0	177.0	2.68	220.5	2.97		
480.0	177.9	2.70	221.1	2.98		
485.0	178.8	2.71	221.7	2.98		
490.0	179.7	2.73	222.3	2.99		
495.0	180.7	2.74	222.8	3.00		
500.0	181.6	2.75	223.4	3.01		
505.0	182.5	2.77	223.9	3.01		
510.0	183.4	2.78	224.5	3.02		
515.0	184.3	2.80	225.0	3.03		
520.0	185.2	2.81	225.6	3.04		
525.0	186.0	2.82	226.1	3.04		
530.0	186.9	2.84	226.7	3.05		
535.0	187.8	2.85	227.2	3.06		
540.0	188.7	2.86	227.7	3.06		
545.0	189.6	2.88	228.2	3.07		
550.0	190.4	2.89	228.8	3.08		

<sup>1</sup> As received and stabilized ratings at STC (1000 W/m<sup>2</sup>, AM1.5, (25  $\pm$  2) °C Cell Temperature)  $\pm 10\%$

<sup>2</sup> Measurement uncertainty applies



Table 2: Temperature Characteristics

TEMPERATURE CHARACTERISTICS		
Module Operating Temperature Range	(°C)	-40 to +85
Temperature Coefficient of $P_{MAX}$	$T_k(P_{MAX})$	-0.32%/°C (Temperature Range: 25°C to 75°C)
Temperature Coefficient of $V_{oc}$	$T_k(V_{oc})$	-0.28%/°C
Temperature Coefficient of $I_{sc}$	$T_k(I_{sc})$	+0.04%/°C

## 4.2 WIRING SYSTEM DERATING FACTORS

Under normal operation, a PV module may experience conditions that produce higher current and/or voltage than reported at STC. Accordingly, the values of  $I_{sc}$  and  $V_{oc}$  listed for STC need to be multiplied by a factor of 1.25 when determining component voltage ratings, conductor current ratings, and size of controls connected to the PV output. For UL installations, an additional 1.25 safety factor for short circuit current may be applicable, reference the National Electric Code (NEC) Article 690 for further details. Specific site conditions and local electric code requirements must be used for determining the maximum system voltage.

When calculating module  $V_{oc}$  at 1250 W/m<sup>2</sup>, AM1.5 spectrum, and cell temperature of -10°C, multiply the specific model type STC listed  $V_{oc}$  value by a factor of 1.1. When calculating module  $I_{sc}$  at 1250 W/m<sup>2</sup>, AM1.5 spectrum, and cell temperature of 75°C, multiply the specific model type STC  $I_{sc}$  value by a factor of 1.27.

The safety factor of 1.25 given for the minimum voltage rating of the components in the example statement above may be modified during the design of a system according to the minimum temperature of the installation location and the temperature coefficient for  $V_{oc}$ . The safety factor of 1.25 given for conductor current ratings values for  $I_{sc}$  may be adjusted based on the maximum values of irradiance incident on the front side of the module. To this purpose, a full simulation for the specific location and module orientation is required. Further guidance for the choice of a safety factor other than 1.25 is given in the NEC.

As per NEC 690 (A) an acceptable method of calculating  $V_{oc}$  is published by Sandia National Laboratories (reference SAND 2004-3535, *Photovoltaic Array Performance Model*). This model uses irradiance and temperature of a given location to forecast expected open circuit Voltages on a project specific basis.

# 5 HANDLING & STORAGE

## WARNING



Packs are heavy and must be transported at site in a safe manner.

- Only authorized forklift drivers should operate a forklift to move module packs.
- **Long side pack handling** is recommended after truck unloading.
- Ensure use of correct fork lengths.
- Forks must be safely engaged. Center of gravity and tipping loads must be considered for safe site transportation.

When handling packs using forklifts or other mechanical aids, ensure uniform pack support, and the forks fully extend under the pallet. Packs can be lifted from either the short or long side of the pallet.

## 5.1 TRUCK/CONTAINER UNLOADING

- **Requirements:**
  - Refer to table 3 below for minimum and maximum fork engagement requirements.
  - All equipment handling packs must have a minimum mast width of 2.3m (92.5in) and minimum height of 1.1m (44in) or use a jig meeting these guidelines.



Figure 1: Example of Mast/Jig

- **Recommendations:**
  - Tilt angle between 0 and 10 degrees.

## CAUTION



First Solar is not responsible for the transportation of modules from the original point of destination listed in the purchase order under which the modules are sold to another location. Any damage to the pack, pallet, or modules that are determined to be caused by transportation to an alternate location not specified in the purchase order shall be the sole responsibility of the owner.

## 5.2 ON-SITE PACK HANDLING

- **Requirements:**

- Refer to table 3 below for minimum fork engagement requirements.
- All equipment handling packs must have a minimum mast width of 2.3m (92.5in) and minimum height of 1.1m (44in) or use a jig meeting these guidelines.
- Packs must be completely closed during all transit, with the exception of active unpack and install.

- **Recommendations:**

- Long side forklift engagement.
- Tilt angle between 10 and 15 degrees.
- Slow traveling speed.

**Table 3: Pack Dimensions & Fork Engagement Requirements**

Number of Modules in Pack	Pack Dimensions (L x W x H)	Minimum Fork Engagements		Maximum Fork Engagements Truck	Pack Weight
		On Site	Truck		
30	2390 x 1130 x 1551mm (94.1 x 44.5 x 61.1in)	Short Side - 1.82m (71.65in) Long Side - 1.07m (42.13in)	1.07m (42.13 in)	1.15m (45.28in)	1340 kg (2954 lbs.)
44	2390 x 1519 x 1551mm (94.1 x 59.8 x 61.1in)	Short Side - 1.82m (71.65in) Long Side - 1.46m (57.48)	1.46m (57.48 in)	1.54m (60.63in)	1813 <sup>3</sup> /1870 kg (3997 <sup>3</sup> /4114 lbs.)
46	2390 x 1582 x 1551mm (94.1 x 62.3 x 61.1in)	Short Side - 1.82m (71.65in) Long Side - 1.52m (59.84in)	1.52 m (59.84 in)	1.6m (63 in)	2004 kg (4418 lbs.)

**CAUTION**



The forklift must be able to safely handle the load.



**Figure 2: Correct Engagement Points for Lifting Pack from Long Side**

<sup>3</sup> +/-1300mm mounting location added to product variant

**CAUTION**

- Failure to meet fork engagement lengths may cause damage to the modules or pack. Make sure lifting equipment meets specifications based on the dimensions and weight of the pack.
- The fork engagement points shown in green in Figure 2 must be utilized.
- Ensure symmetrical fork engagement at pack lifting points.

### 5.3 ON-SITE STORAGE

- **Requirements:**
  - Packs must be stored on flat, firm and stable level ground.
  - Packs must **not be** stored in a manner that causes debris to come into contact with the packs or modules (including, without limitation, storage in windy areas which may be susceptible to displacement of debris).
  - Packs must **not be** stacked on site.
    - For prolonged warehouse storage please contact First Solar at [technicalsupport.NA@firstsolar.com](mailto:technicalsupport.NA@firstsolar.com) for guidance and evaluation of pack stacking.
  - Packs must **not be** exposed to standing water or saturated ground.
  - Packs must **not be** exposed in the field for longer than 6 weeks.
  - Packs must be kept dry.

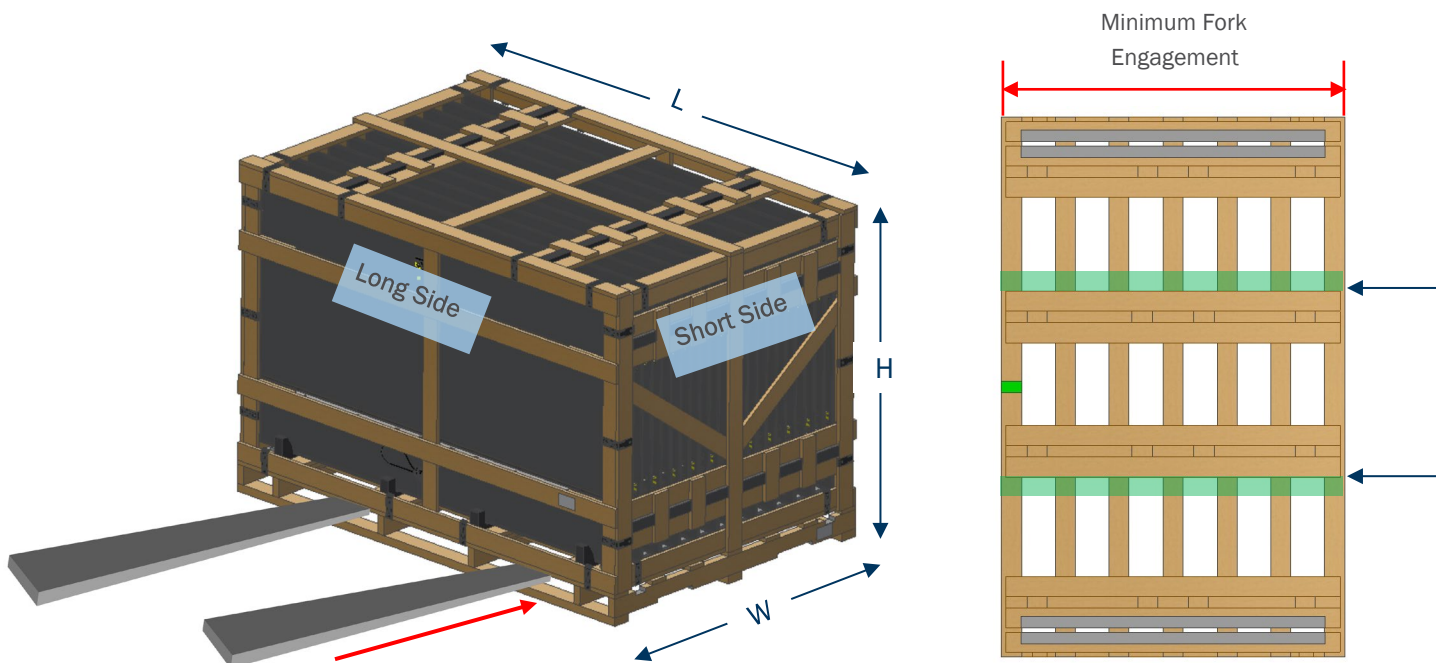

Figure 3: Series 7 TR1 Long Side Forklift Engagement

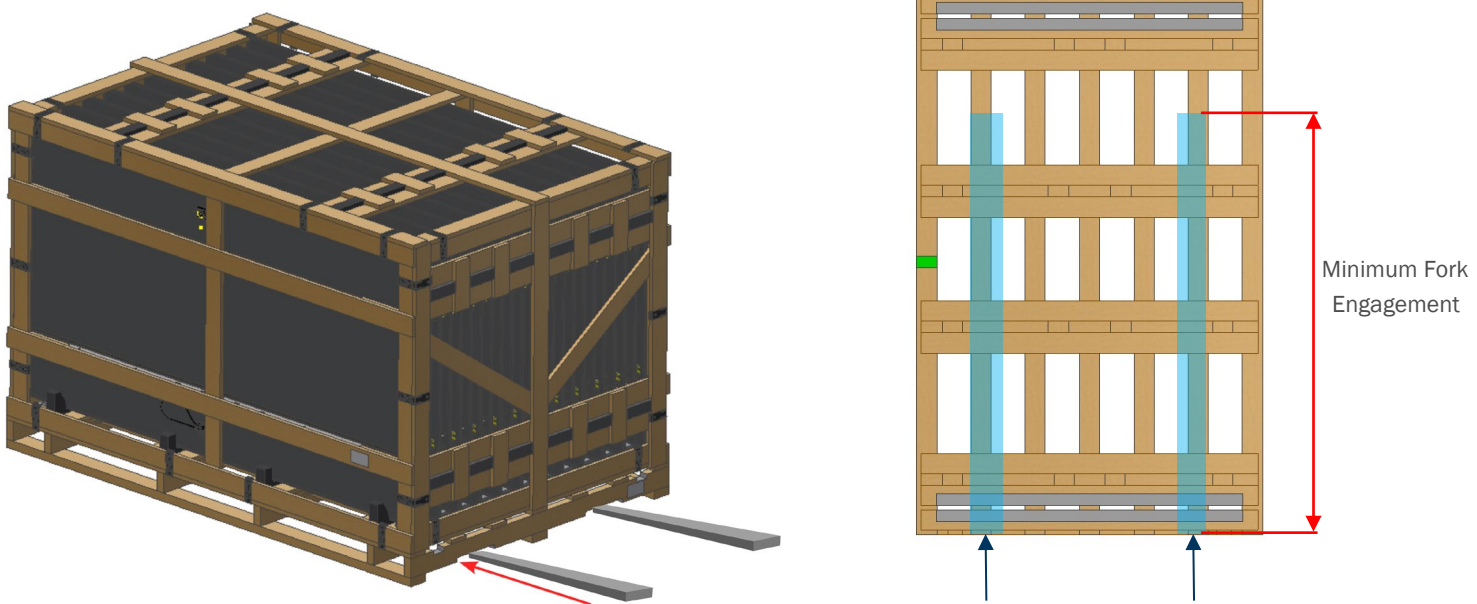

Figure 4: Series 7 TR1 Short Side Forklift Engagement

Modules in a pack may lean or shift on a pallet during shipping. Ensure packs are stable prior to transporting. If any damage is observed, use the Delivery Note to document affected pallets and contact [technicalsupport.NA@firstsolar.com](mailto:technicalsupport.NA@firstsolar.com).

Please evaluate site conditions for safe pack storage as uneven or recently disturbed ground and moisture may affect pack stability. Packs are not intended for outdoor storage longer than 6 weeks. Packs must not be exposed to standing water or saturated ground.

#### CAUTION



- To prevent glass scratches, modules should be removed from the long side only and not by sliding across each other.
- **Short side module unpacking is prohibited.** Long-side unpack methods reduce the risk of glass scratches and/or ARC abrasion.

#### WARNING



Open the packaging with care. A single person should not attempt to lift a Series 7 TR1 module. **Lift the modules from the pallet with two or more persons or with lift assist.** Do not attempt to lift multiple modules at the same time.

During handling and installation, do not make abrasive contact with top glass surface to prevent scratches of ARC film.

# 6 MECHANICAL SPECIFICATIONS

Table 4: Module Mechanical Specifications

SPECIFICATION	Series 7 TR1 (FS-7XXXA-TR1)
Module Weight	38.4 <sup>3</sup> / 39.7 kg ± 3.5 kg (84.66 <sup>3</sup> / 87.5 lbs. ± 7.7 lbs.)
Height	56 mm (2.2 in)
Length	2300 mm ± 2.5 mm (90.5 in ± 0.08 in)
Width	1216 mm ± 2.5 mm (49.0 in ± 0.08 in)
Total Area	2.80 m <sup>2</sup> (30.0 ft <sup>2</sup> )
Junction Box Lead Wire <sup>4</sup>	2.5 mm <sup>2</sup> (14 AWG) 650 mm (25.59 in) (+) & Bulkhead (-)
Fire Performance <sup>5</sup>	Type 19: Class A Spread of Flame / Class C Burning Brand
Frame/Rail	Steel with galvanization G115

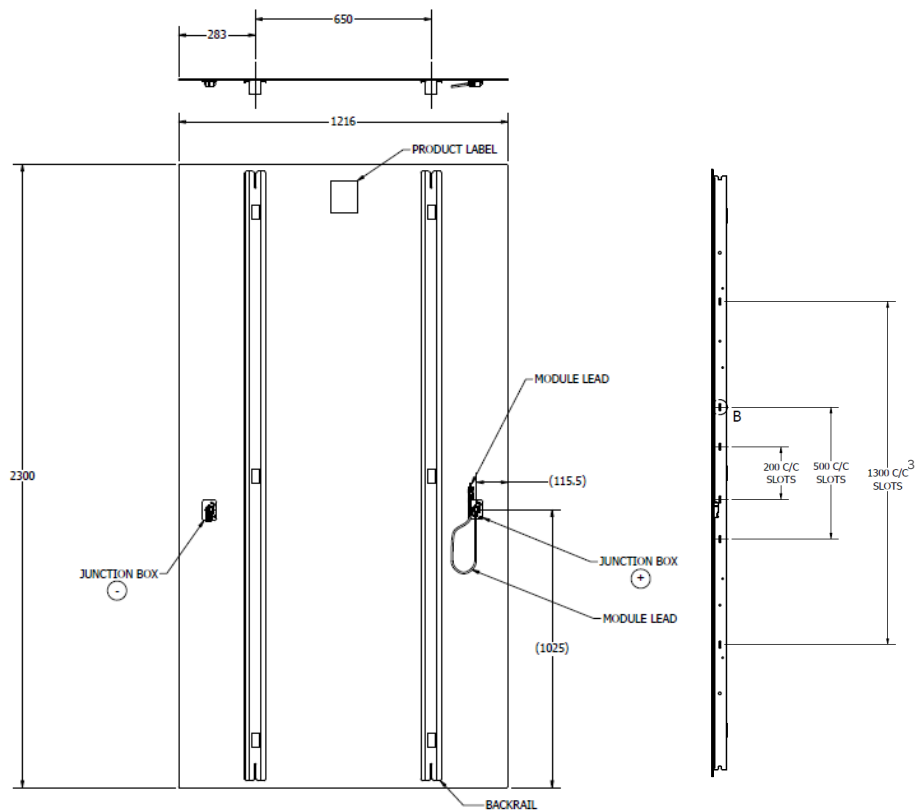

Figure 5: Series 7 Module Mechanical Drawing

<sup>4</sup> Length from junction box exit to connector mating surface

<sup>5</sup> Module UL 61730 fire rating is valid only when mounted in the manner specified in this User Guide. Roof mounted fire rating is established by assessing rack and module as a unit. External fire source resistance has not been evaluated.

# 7 INSTALLATION & MOUNTING

## 7.1 MOUNTING

It is best practice to complete heavy construction and trenching prior to module installation to minimize module exposure to dust. Ensure any site preparation or maintenance chemicals (soil binding agents or chemicals used for on-site dust control or weed control) do not spray, splash, or drift onto the surface of the modules or its associated components.

It is the responsibility of the qualified engineer and/or qualified installer to ensure the system and its components meet applicable structural and electrical code requirements for the product application's jurisdiction and to evaluate the product specifications are suitable for the application environment.

First Solar is not responsible for bonding failure, breakage, damage, wear, corrosion, or module performance issues that are deemed to be caused by design or installation practices that do not comply with this User Guide.

### CAUTION



#### Safety hazards or potentially unsafe practices:

- ▶ Modules must only be installed, operated, maintained or used by qualified personnel for their intended use.
- ▶ Do not install the modules during high wind or wet conditions.
- ▶ Handle modules with care during installation, as heavy impact to the front, back, or edge could result in damage to the module. Do not impact module with hammer to aid installation process.
- ▶ Do not walk, stand, or sit on modules.
- ▶ Do not carry multiple modules on top of one another after removal from pack.
- ▶ Do not lift or pull on modules using lead wire or junction boxes.
- ▶ Do not rest objects (such as tools, etc.) on module glass.

Modules must have adequate ventilation and airflow to prevent operating temperatures above 85°C.

## 7.2 MOUNTING LOCATIONS & LOAD RATINGS

The interface of the mounting structure to the module back rails must meet the technical requirements specified in this User Guide. The mounting system design must provide adequate support for the module to prevent load damage from occurring based on the loading requirements for the given application and the chosen mounting locations. Structures must not come into direct contact with the surface or edges of the module glass.

Modules can be secured to the support structure with clips using the symmetric mounting holes on the back rail.

Series 7 TR1 modules have been evaluated to operate in an ambient air temperature range of at least -40°C to +40°C and have been tested to wind/snow loads as detailed in Table 5. Test loads include a safety factor of 1.5 above the design loads.

Series 7 TR1 modules meet the following load ratings when mounted as specified in this User Guide and evaluated according to the listed standard in Table 5.

**Table 5: Module Load Ratings**

Symmetrical Four-point Mount Location	IEC 61215 / IEC 61730 / UL 61730	
	Design Load	Test Load
200mm	± 1600 Pa (± 33.4 lbs./ft <sup>2</sup> )	± 2400 Pa (± 50.1 lbs./ft <sup>2</sup> )
500mm	± 2133 Pa (± 44.5 lbs./ft <sup>2</sup> )	± 3200 Pa (± 66.8 lbs./ft <sup>2</sup> )
1300mm <sup>6</sup>	± 1600 Pa (± 33.4 lbs./ft <sup>2</sup> )	± 2400 Pa (± 50.1 lbs./ft <sup>2</sup> )

Symmetrically secure the module using a minimum of four back rail contact points. Other mounting solutions not discussed in this User Guide (Such as - asymmetric mounting, higher load ratings, alternative clamp geometry, etc.) may be permitted, but require evaluation by First Solar ([technicalsupport@firstsolar.com](mailto:technicalsupport@firstsolar.com)). First Solar reserves the right to reasonable access to validate proper installation.

- ▶ The modules must have a minimum spacing gap of 15 mm (0.59 in) between each other. Usable junction box lead wire lengths accommodate spacing up to 245 mm (9.65 in) (assuming no substructure interference).
- ▶ Modules must not contact overlap or otherwise apply a lateral force on one another once installed in PV system.
- ▶ Do not attempt to mount directly to module glass edge. Do not modify module back rails in any way. This includes drilling additional holes, altering mounting features or otherwise cutting, trimming, or shaping any part of the module back rails.
- ▶ Module attachment hardware (i.e. clips, bolts, etc.) must not contact the module glass.
- ▶ Mounting clamps certified/ designed to electrically bond and/or ground the module back are allowed when used in accordance with the clip manufacturer's instructions.
- ▶ Install hardware may not put a compression load on the back rails.

Mounting hardware that does not meet the minimum requirements may not preserve module certifications or warranty and must be evaluated by First Solar ([technicalsupport@firstsolar.com](mailto:technicalsupport@firstsolar.com)).

<sup>6</sup> Only on new product variant



### 7.3 BACKRAIL MOUNTING

Series 7 TR1 module back rails include 4 or 6<sup>3</sup> slotted holes through each rail. Mounting Clips must extend beyond either side of the mounting bracket or have a retention feature to prevent module back rail dislodgement under load. Clips must rest on the flat surface of the slotted hole and mounting bracket. Back rail mounting features must be designed with adequate bearing surfaces to prevent module damage under ultimate loads and consider any bending moments from unbalanced loads.

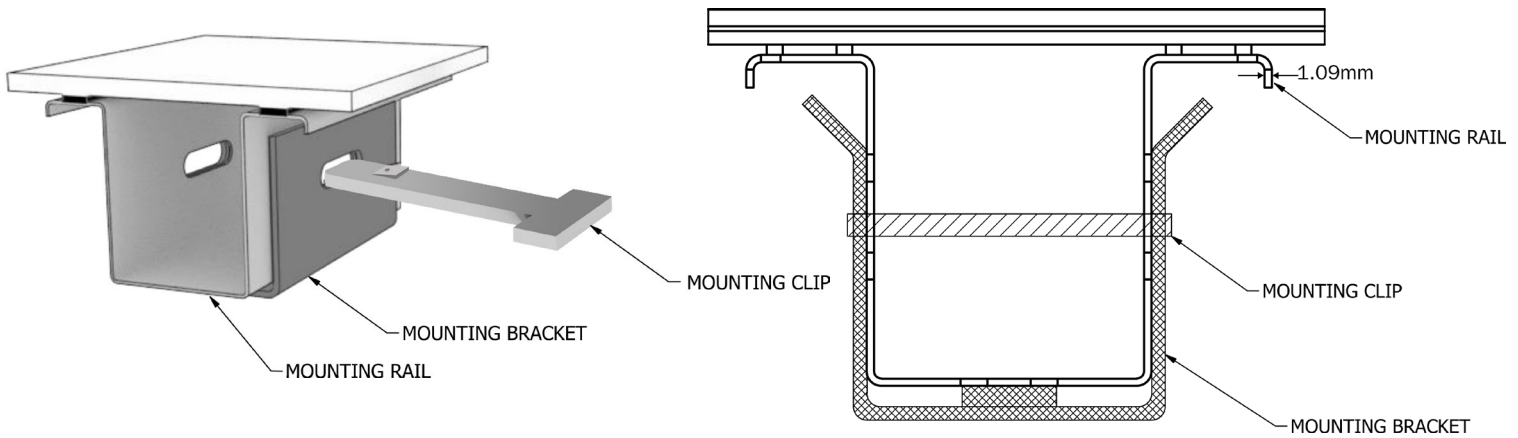

Figure 6: Bracket and Clip Mounting Details

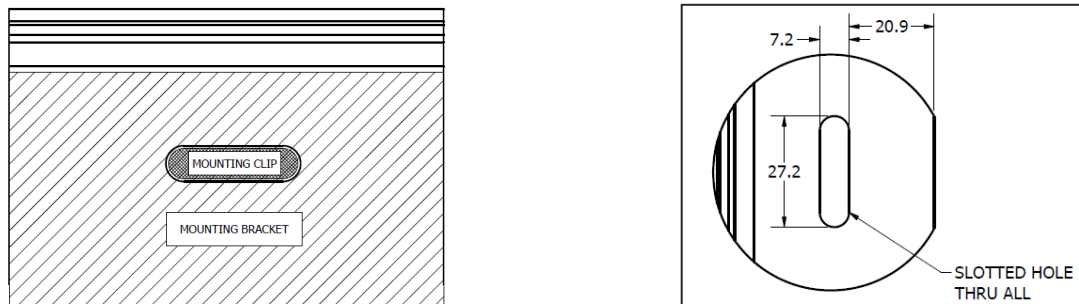

Figure 7: Slotted hole dimensions

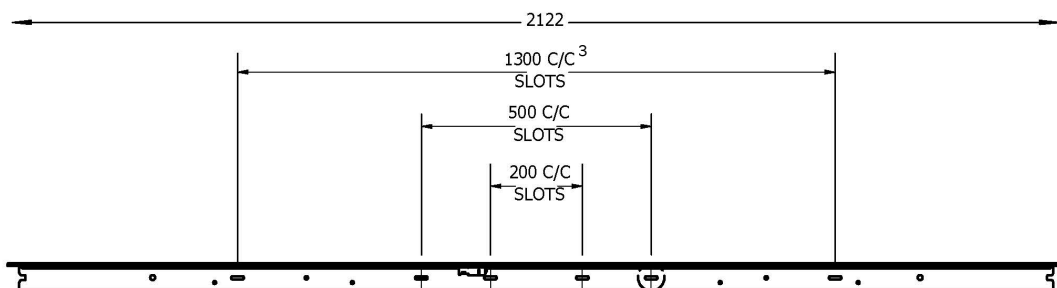

Figure 8: Slot Distance from Backrail Centerline. The nominal rail thickness is 0.89<sup>3</sup>/1.09mm

## 7.4 MODULE ORIENTATION

PV performance modeling software, such as PlantPredict software by Terabase Energy Inc. (<http://www.plantpredict.com>), should be used to determine the optimum orientation and tilt angle for each location.

Mount modules in portrait orientation for applications where row-to-row shading could occur. Landscape orientation is permitted only in flat mount applications where the module long side is not completely shaded and when compliant with Section 7.4 Module Shading Considerations.

## 7.5 MODULE SHADING CONSIDERATIONS

Specific shading patterns can cause damage to module cells due to the creation of localized areas of reverse bias. Reverse bias is generated by one or more series-connected cells being shaded while the rest of the cells are fully illuminated.

There is no risk of module damage due to shading that occurs while modules are in open circuit. Shading that occurs at a distance greater than 2 m (6.6 ft), also known as diffuse shading, carries reduced risk and must be avoided where possible. Row-to-row shading of modules installed in portrait orientation is acceptable.

There is a low risk of module damage due to shading from repeatedly walking or standing in front of operating modules or from repeatedly parking or driving vehicles in front of operating modules during illuminated times. It is best practice to stay close to the backside of the adjacent rack as one travels down a row of operating modules.

Do not subject modules to high-risk shading instances listed below:

- ▶ Resting or adhering slender objects (tools, brooms, clothing, wires, tape) on front-side of operating modules, or when within ~2 m (~6.6 ft) above operating modules, especially when the shadow is oriented parallel to cells
- ▶ Fixed objects within ~2 m (~6.6 ft) above operating modules that cast a shadow over the long dimension of the cells. Close objects (posts, ropes, fences, etc.) can begin to increase risk of partial shading of full cells when within ~2 m (~6.6 ft) from the front-side of operating module
- ▶ A support to the back rails or mounting method of modules that fully shades the entire length of a cell (either partially or completely)
- ▶ Cleaning robots or other mechanisms that traverse the module while the system is operating
- ▶ Row-to-row shading when the modules are installed in landscape orientation
- ▶ Closely “stair-stepped” trackers on northerly slopes (northern hemisphere), or southerly slopes (southern hemisphere).

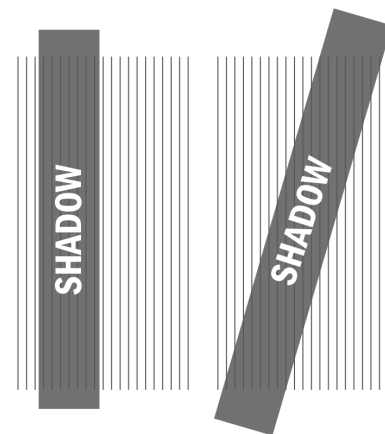
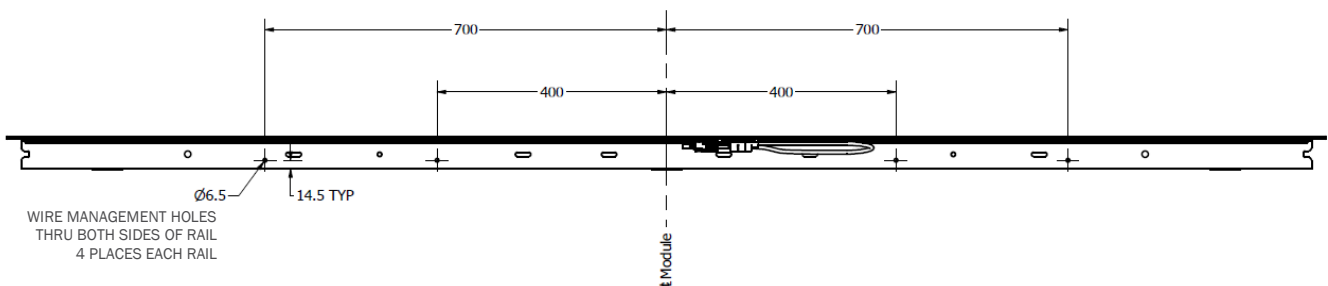

Figure 9: Example of at-risk shading patterns

## 7.6 WIRE MANAGEMENT

All wire management must comply with the applicable NEC/IEC codes and standards for maintaining and managing wires, as well as any applicable local requirements determined by local authorities having jurisdiction. This document includes evaluation of general wire management requirements based on interpretation of the following codes and standards and does not substitute for a comprehensive evaluation of applicable requirements:

- ▶ NEC 2020
  - 300.3(C)(2) – Conductors of Different Systems
  - 334.30 – Support and Securement Spacing
  - 338.24 – Cable Bend Radius Requirements for Type USE cable
- ▶ IEC
  - 62548:2016, 7.3.7.3 – Erection Method
  - 62548:2016, 7.3.8 – Segregation of AC and DC Circuits
  - 60364-5-52:2009, 522.8.3 – Cable Bend Radius



**Figure 10:** Wire Management Hole Dimensions

Below is a list of best practices that applies to the majority of wire management scenarios:

- ▶ The connectors, X/T joints, and in-line fuses should not be in direct contact with the metal back rail or structure. It is recommended that insulated cables do not come in direct contact with the metal back rail or structure, unless unavoidable, to minimize stresses on components.
- ▶ The installation of harnesses, harness jumpers, harness whips, and PV array cables (or “Homerun” cables) should not subject the connectors, X/T joints, and in-line fuses to tensile loads.
- ▶ Cable ties should be a minimum distance of 25 mm (1 in) from connectors, X/T joints, and in-line fuses.
- ▶ Cables should not maintain constant contact with the edges of glass-to-glass solar module laminates.
- ▶ Cable ties should be tensioned such that there is at least 13 mm (0.5 in) (two-finger-gap) between the top of the cable bundle and the bottom of the back rail.

Typically, the lead wire connection does not require wire retention or securement due to the proximity of the junction boxes on adjacent modules.

Above-ground DC cabling (typically a bundle of harness and homerun PV cables) may be supported by utilizing the wire management holes located on the back rails. The maximum cable weight carried by each module in totality may not exceed 3.5 kg (7.6 lbs.). Do not use junction box for wire management attachment.

## 7.7 ELECTRICAL INTERCONNECTION

All electrical components that are interconnected to modules must have an operating voltage range that matches the maximum power point of the array and be capable of operating the array at the maximum power point at all times. Short circuit operation is permitted only during short duration system safety testing or in fail-safe system states.

Series 7 TR1 modules are pre-configured with industry standard connectors that are “touch proof” with all live parts protected against accidental contact and protected against polarity reversal. The cables and connectors are UV and weather resistant from  $-40^{\circ}\text{C}$  to  $+85^{\circ}\text{C}$  and rated for 1500 VDC.

Series 7 TR1 modules use TE Connectivity (<https://www.te.com>) PV4-S connectors (PV4-S1F/PV4-S1M). Module-to-module and module-to-harness interconnection must utilize the same manufacturer and type of connectors. First Solar cannot guarantee that connectors from different manufacturers or type of connectors will be mateable. Any damage to the module resulting from any such interconnection will not be covered by the First Solar module warranty.

### CAUTION



**Damaged wires, connectors, or junction boxes may cause ground faults, and associated electrical hazards, including electrical shock.** To avoid these conditions:

- ▶ Protect unmated connectors from dust and moisture by using sealing caps (not provided, available from connector manufacturer).
- ▶ Limit module connectors to 10 or fewer plug cycles.
- ▶ Do not pull junction box lead wires tight. After installation, connected wire must not be under stress or tension.
- ▶ The minimum module junction box lead wire bend radius is five times the wire diameter. Observe minimum bend radius specifications on all other PV system wiring.
- ▶ Do not use junction box assembly to bear weight greater than that of a (properly wire managed) module's own wire and mated connection.
- ▶ Secure wire or connected components so they are hanging greater than 0.46 m (1.5 ft) above the ground in free field applications, and so they are hanging clear of roof coverings or pooled water in rooftop applications.
- ▶ Ensure connectors are fully mated and locking clip on connector engages.
- ▶ Do not loosen, alter, or modify the factory-installed connectors on the module junction box. Do not attempt to unscrew or tighten connector back nut.
- ▶ Ensure wire securement methods, such as use of cable ties, do not damage wire insulation.
- ▶ Ensure wires are not in contact with sharp edges of the mounting structure to avoid abrading the wire sheath.
- ▶ Inspect and maintain wire management requirements over the life of the plant.
- ▶ Do not expose modules, wires, junction box, or connectors to environments with the following substances, as they may incur damage and affect module safety or performance: greases, oils, lubricants, plasticizers and organic solvents (including aliphatic hydrocarbons, aromatic hydrocarbons, halide hydrocarbons, ketones, alcohols, ethyl acetate, tributyl phosphate, kerosene and gasoline).

Wiring harnesses are recommended in system designs. The shorter string size and low string current of Series 7 TR1 modules make it possible to connect multiple strings together in parallel and return a single pair of DC cables to the combiner box or string inverter. Design wiring harnesses that are optimal for the structural layout. Modules per row can vary by structure manufacturer and site design criteria. For example, a structure with 84 modules per row typically uses two, 7-string harnesses in the DC design in a 1500 VDC system.

Components used to interconnect the modules must be compatible with the connectors, and provide proper system operation and fault protection as required by applicable codes. Field wiring must be rated for 90°C and be of a type approved for use in accordance with the NEC (US only).

#### Positive Connector



#### Negative Connector

(integrated as part of module bulkhead junction box)



Figure 11: PV4-S Connectors of Part Numbers (PV4-S1F/PV4-S1M)

## 7.8 INVERTER COMPATIBILITY

Series 7 TR1 modules are compatible with a range of string, central, transformer, and transformerless inverters. When connecting modules or module strings in series ensure inverter ratings are appropriate.

Do not exceed system design voltage and inverter design specifications when connecting modules in a series string. This is typically ensured by limiting series strings to four modules for 1000 VDC applications or six modules for 1500 VDC applications. Do not connect modules in parallel. Strings of modules can be installed in parallel for DC collection purposes.

The Maximum Power Point (MPP) voltage of a module array must be considered for compatibility with the specified inverter MPP window. Similar to the maximum open-circuit voltage, the MPP voltage of the array is dependent on ambient conditions, and the system should be designed to ensure the array MPP voltage remains within the MPP window for expected operating conditions.

## 7.9 GROUNDING METHOD

- ▶ Functional grounding of conductive non-current carrying parts
  - Typically, the grounding can be achieved by mechanical mounting methods or through other methods using the grounding holes provided, in either case the applicable codes and standards, as well as any applicable local requirements determined by local authorities having jurisdiction must be followed.
  - In addition to the above, any grounding/bonding devices must meet the IEC 61730-2 pass/fail criteria of less than 100 mΩ resistance.
  - The use of common grounding hardware (such as lugs, clips, nuts, bolts, split-ring lock washers, flat washers and the like) to attach grounding/bonding device must be in conformance with the grounding device manufacturer's instructions. Figure 12 below indicates locations of grounding holes for S7 TR1.

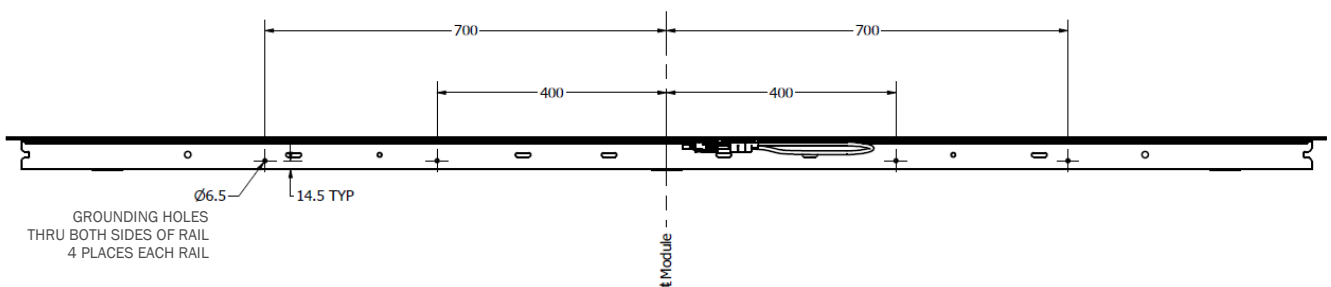

Figure 12: Grounding Hole Dimensions

- ▶ Functional grounding of one current carrying pole
  - First Solar recommends Series 7 TR1 modules be used in negative-grounded systems. Modules must not be subjected to negative voltage bias conditions that can occur in voltage floating or bipolar systems (subjecting modules to conditions that could drive potential induced degradation). If string inverters or other non-negative grounded system architectures are used, alternate methods of preventing negative voltage bias on modules (such as system level voltage controllers/float controllers or integrated inverter array voltage control) must be implemented and include a minimum of hourly logged PV negative voltage to ground to demonstrate compliance in event of a future warranty evaluation. Series 7 TR1 modules must not be used in positive-grounded systems.

### NORTH AMERICAN PROJECTS ONLY

For North America, a module with exposed conductive parts is considered to comply with UL 61730 only when it is electrically grounded in accordance with the instructions presented and the requirements of NFPA 70: National Electrical Code, article 250.

The module is considered to be in compliance with this standard only when the module is either mounted in the manner specified by the mounting instructions, or when the mounting means has been evaluated with this PV module to UL 2703. A module with exposed conductive parts is considered to be in compliance with this standard only when it is either electrically grounded in accordance with the manufacturer's instructions and the requirements of the National Electrical Code, ANSI/NFPA 70, or when the bonding means has been evaluated with this PV module to UL 2703.

Grounding kits containing 5/16-32 (M8x0.7) self-threading stainless steel components (Example: self-threading screw, flat washer, and cup washer) or other compatible UL listed hardware can be used to attach copper grounding wire to one of the frame's marked grounding holes per manufacturer instructions. Example:

Slide the flat washer on the screw, followed by the cupped washer with the smaller end of the cup washer closest to the cap bolt head. Affix the copper grounding wire between the flat washer and the cupped toothed washer and tighten the screw securely into the frame grounding hole.

Common hardware items (such as lugs, clips, nuts, bolts, star washers, split-ring lock washers, flat washers and the like) that have not been evaluated or certified for electrical conductivity or for use as grounding devices, must be used only for maintaining mechanical connections and holding electrical grounding devices in proper position for electrical conductivity. Such devices, where supplied with the module and evaluated through the requirements in UL 61730, may be used for grounding connections in accordance with the instructions provided with the module.

Mounting clamps or other hardware components that are UL listed for grounding/bonding may be used in instances where the structure and module have been tested to meet UL 2703.

In order to provide a reliable grounding connection to the module frame, the following hardware or equivalent is required per UL 61730:

- A UL Listed Grounding Lug with paint cutting star washer and 5/16-32 by 3/8 inch thread forming screw.
- A UL Listed grounding strap type EM2050 as manufactured by Electric Motion CO. Inc.
- Grounding means must be secured to grounding hole opening on frame and torqued to 25 in-lbs.

Mounting clamps that are UL listed for grounding/bonding may be used in instances where the structure and module have been tested to meet UL 2703

# 8 MAINTENANCE

## 8.1 MAINTENANCE

Only qualified personnel should perform maintenance on PV systems. Maintenance (cleaning, electrical inspection, etc.) may pose a risk of electrical shock, injury, or module damage.

A regular inspection and maintenance schedule should include, but is not limited to:

- ▶ Annually at a minimum, inspect modules for any signs of damage or broken glass. Replace broken modules immediately.
- ▶ Keep modules free from debris, particulates, or large volumes of snow to maximize system performance.
- ▶ Ensure the module surface pressure is at or below the design load by removing snow.
- ▶ Inspect wiring and wire management periodically.
- ▶ Inspect and confirm electrical connections are tight and corrosion free.
- ▶ Avoid using brush/ground maintenance tools (Example: weed trimmer, brush cutter, etc.) that could send projectiles toward module glass.

The most common causes of lower than expected PV system power output are:

- ▶ Improperly calibrated or malfunctioning monitoring equipment.
- ▶ Inverter failure.
- ▶ Improper or faulty field wiring or connections.
- ▶ Blown fuses or tripped circuit breakers.
- ▶ Excessive amounts of dirt and dust on the modules.
- ▶ Shading of modules by trees, poles, or buildings.

It is normal for the modules to exhibit visual irregularities, which do not impact power. ARC modules are more likely to exaggerate the visual appearance of scratches, fingerprints, and other blemishes due to the optical properties of the glass interface.

Snowdrifts may result in a non-uniform loading of modules. If it is expected that snow loads will exceed design, clear snow from modules to ensure that ice/thaw/freeze cycles under snow drifts do not result in excessive stresses on the module.

Varying snow conditions may be cleared from the modules when using dry cloths or mops. Other snow clearing methods, such as blowers, may be used depending on snow conditions and if approved by First Solar. To prevent pile up and overload, periodically clearing snow from the bottom modules first in an array is a critical process.



## 8.2 MODULE CLEANING GUIDANCE

Modules do not require cleaning in most climates. Installed modules may collect a light layer of dust and/or dirt (soiling) over time and periodic rainfall should be sufficient to remove light soiling in most cases. In locations with heavy soiling, properly timed module cleaning can improve energy yields.

### CAUTION



Cleaning activities create risk of damage to the modules and array components, as well as the potential for electric shock.

Cleaning may reduce energy enhancing effects of anti-reflective coating.

### CAUTION



Cracked or broken modules represent a shock hazard due to leakage currents and the risk of shock increases when modules are wet. Before cleaning, thoroughly inspect modules for cracks, damage, and loose connections.

The voltage and current present in an array during daylight hours are sufficient to cause a lethal electrical shock.

Only properly trained personnel who understand the risks of applying water to electrical components should clean modules. Trained personnel must wear appropriate electrically insulating Personal Protective Equipment (PPE) during cleaning, inspection operations, or when working near modules. Professional cleaning services trained to work on live electrical systems are available for hire.

Clean modules only when in open circuit (reference Section 7.5 Module Shading Considerations) – either disconnected from load, or during times when the inverter is off. The recommended time to clean modules is from dusk to dawn when production is not affected, and risk of electrical shock hazard is minimized. The following guidelines minimize impact to plant power generation, reduce safety hazards, and minimize risk of module damage.

### Important

---

*First Solar does not warrant against breakage, damage, wear, or module performance issues that are determined to be caused by module cleaning.*

---

## Cleaning Requirements

---

- ▶ When dry cleaning, it is required to use soft mops or soft cloths only.
- ▶ When using water, RO water provides the best results. When RO water is not available, tap water with low mineral content (total hardness <75 mg/L) or deionized water may be used. Calcium must not exceed 75 mg/L.
- ▶ Fresh water (TDS < 1500 mg/L) may be used to clean the modules. If needed, a mild, non-abrasive, non-caustic detergent with a final fresh water and detergent solution mix between  $6.5 < \text{pH} < 8.5$  at  $25^{\circ}\text{C}$  may be used. Do not use abrasive cleaners or degreasers, cleaning solutions containing hydrochloric acid, D-Limonene, ammonia, or sodium hydroxide.
- ▶ Water temperature must be  $< 20^{\circ}\text{C}$  from module temperature applied with water pressure  $< 35$  bar (500 psi) at nozzle.
- ▶ Water must be free of floating oil or other immiscible liquids, floating debris, excessive turbidity, and objectionable odors.
- ▶ Chlorides must not exceed 250 mg/L and water conductivity must be  $< 250$  mS/cm.
- ▶ If necessary for localized cleaning, excessively soiled spots on modules (i.e. bird droppings) may be spot-cleaned with soft cloth or mop and water.
- ▶ Do not direct pressurized water at sealed interfaces of module (junction box, edge seal, and connectors).
- ▶ Avoid cleaning backside of modules to prevent accidental stress to lead wire or junction box.

Cleaning solutions vary in design and size and can affect the load dispersed onto the modules.

Evenly distributed load per module while cleaning must not exceed 40.8 kg (90 lbs.).

- ▶ Uneven loads and pressures (wheels or belts) must be avoided.
- ▶ The following load scenarios must not be exceeded:
  - Point loads (P1)
    - Max of 13.6 kg (30 lbs.) each spaced 40.6 cm (16 inches) apart.
  - Up to 0.18 kg/cm (P2) (1 lbs./inch) of contact length for a drive belt anywhere on the module.
  - Up to 0.18 kg/cm (P3) (1 lbs./inch) of contact length for brushes contacting the module anywhere on the module.
  - Any combination of the above load types so that the total of P1, P2, and P3  $\leq 40.8$  kg (90 lbs.) normal to the surface of the module.
- ▶ No feature of a cleaning solution must extend around the edge or contact the back surface of the module.
- ▶ Cleaning solutions must not affect or jeopardize any part of the mounting system.
  - This includes all parts of the mounting system: clips, rails, and trackers.

## Robotic Cleaning Requirements

---

- ▶ Minimize vibration from the cleaning apparatus to prevent shifting of the modules in their mounting hardware.
- ▶ Edges of Series 7 modules are unsupported and unprotected, and as such must not be used to support the weight of the robotic cleaning system.
- ▶ Robotic cleaning systems are restricted from using the module glass edge as a guide or mechanical support for the load of the robot, exemptions may be evaluated and approved by First Solar on a case by case basis.
- ▶ Module edges must not be used as drive surface.
- ▶ The robot must have a smooth transition from module to module in order to make sure that there is no impact on the edges.

## 8.3 MODULE DISPOSAL

Modules may be recycled or disposed of in accordance with applicable local requirements.

Please visit [www.firstsolar.com/modules/recycling](http://www.firstsolar.com/modules/recycling) for further details on the recycling program.

# 9 REVISION HISTORY

REVISION NUMBER	AMENDMENT DETAILS	REVISION DATE
1.0	Initial Release	09/14/2022
1.1	Updated Mechanical Drawing	01/24/2022
1.2	“Wiring system derating factors” and “Robot Cleaning” updated, Frame/Rail material added in	10/05/2023
1.3	Pack handling sections have been updated	02/23/2024
1.4	New mounting location	09/03/2024